

CC640

Digital Camera

Operating Manual

Issued 22.11.10

Copyright © 2005-2010 Campbell Scientific (Canada) Corp.
Printed under Licence by Campbell Scientific Ltd.

Guarantee

This equipment is guaranteed against defects in materials and workmanship. This guarantee applies for twelve months from date of delivery. We will repair or replace products which prove to be defective during the guarantee period provided they are returned to us prepaid. The guarantee will not apply to:

- Equipment which has been modified or altered in any way without the written permission of Campbell Scientific
- Batteries
- Any product which has been subjected to misuse, neglect, acts of God or damage in transit.

Campbell Scientific will return guaranteed equipment by surface carrier prepaid. Campbell Scientific will not reimburse the claimant for costs incurred in removing and/or reinstalling equipment. This guarantee and the Company's obligation thereunder is in lieu of all other guarantees, expressed or implied, including those of suitability and fitness for a particular purpose. Campbell Scientific is not liable for consequential damage.

Please inform us before returning equipment and obtain a Repair Reference Number whether the repair is under guarantee or not. Please state the faults as clearly as possible, and if the product is out of the guarantee period it should be accompanied by a purchase order. Quotations for repairs can be given on request. It is the policy of Campbell Scientific to protect the health of its employees and provide a safe working environment, in support of this policy a "Declaration of Hazardous Material and Decontamination" form will be issued for completion.

When returning equipment, the Repair Reference Number must be clearly marked on the outside of the package. Complete the "Declaration of Hazardous Material and Decontamination" form and ensure a completed copy is returned with your goods. Please note your Repair may not be processed if you do not include a copy of this form and Campbell Scientific Ltd reserves the right to return goods at the customers' expense.

Note that goods sent air freight are subject to Customs clearance fees which Campbell Scientific will charge to customers. In many cases, these charges are greater than the cost of the repair.



Campbell Scientific Ltd,
Campbell Park, 80 Hathern Road,
Shepshed, Loughborough, LE12 9GX, UK
Tel: +44 (0) 1509 601141
Fax: +44 (0) 1509 601091
Email: support@campbellsci.co.uk
www.campbellsci.co.uk

PLEASE READ FIRST

About this manual

Please note that this manual was originally produced by Campbell Scientific Inc. primarily for the North American market. Some spellings, weights and measures may reflect this origin.

Some useful conversion factors:

Area: 1 in ² (square inch) = 645 mm ²	Mass: 1 oz. (ounce) = 28.35 g 1 lb (pound weight) = 0.454 kg
Length: 1 in. (inch) = 25.4 mm 1 ft (foot) = 304.8 mm 1 yard = 0.914 m 1 mile = 1.609 km	Pressure: 1 psi (lb/in ²) = 68.95 mb
	Volume: 1 UK pint = 568.3 ml 1 UK gallon = 4.546 litres 1 US gallon = 3.785 litres

In addition, while most of the information in the manual is correct for all countries, certain information is specific to the North American market and so may not be applicable to European users.

Differences include the U.S standard external power supply details where some information (for example the AC transformer input voltage) will not be applicable for British/European use. *Please note, however, that when a power supply adapter is ordered it will be suitable for use in your country.*

Reference to some radio transmitters, digital cell phones and aerials may also not be applicable according to your locality.

Some brackets, shields and enclosure options, including wiring, are not sold as standard items in the European market; in some cases alternatives are offered. Details of the alternatives will be covered in separate manuals.

Part numbers prefixed with a “#” symbol are special order parts for use with non-EU variants or for special installations. Please quote the full part number with the # when ordering.

Recycling information



At the end of this product's life it should not be put in commercial or domestic refuse but sent for recycling. Any batteries contained within the product or used during the products life should be removed from the product and also be sent to an appropriate recycling facility.

Campbell Scientific Ltd can advise on the recycling of the equipment and in some cases arrange collection and the correct disposal of it, although charges may apply for some items or territories.

For further advice or support, please contact Campbell Scientific Ltd, or your local agent.



Campbell Scientific Ltd, Campbell Park, 80 Hathern Road, Shepshed, Loughborough, LE12 9GX, UK
Tel: +44 (0) 1509 601141 Fax: +44 (0) 1509 601091
Email: support@campbellsci.co.uk
www.campbellsci.co.uk

Contents

*PDF viewers note: These page numbers refer to the printed version of this document.
Use the Adobe Acrobat® bookmarks tab for links to specific sections.*

1. Specifications	1
2. Introduction	2
2.1 Connecting	2
2.1.1 Standalone Mode	3
2.1.2 Power and Pulse Connections.....	3
2.1.3 Datalogger and MD485 Multiplexer Connections.....	3
2.2 Configuring	4
2.3 Operating.....	4
2.4 Retrieving Images	4
2.5 Additional Reference Material	4
2.6 CC640 Quick Check List	4
3. Camera Hardware Description	5
3.1 Terminal Block Connections.....	5
3.2 Power Switch	5
3.3 Snap Button.....	6
3.4 Setup Button.....	6
3.5 Video Output.....	6
3.6 External I/O Connector	6
3.7 LED (Green)	7
3.8 CompactFlash Memory Card	7
3.8.1 Firmware Update From Memory Card	8
3.9 CS I/O and RS-232 Connections.....	8
4. Communication.....	8
4.1 PakBus Communication.....	8
4.2 Connection Kit #19504	9
4.3 RS-232 Port.....	10
4.4 CS I/O Port.....	12
4.5 RS-485 Port.....	14
5. Device Configuration Utility.....	14
6. Operational Description	18
6.1 Self Timed Mode.....	18
6.2 External Trigger Mode.....	18

7. Image Quality	18
7.1 Lighting Conditions.....	18
7.2 Night Time Images	19
7.3 Date and Time Stamp	19
7.4 JPEG Compression.....	20
8. Lens	20
8.1 Focus and Zoom Adjustment.....	20
8.1.1 Temperature Variations and Focus	21
8.2 Lens Filter	21
9. Maintenance	22
9.1 Lithium Battery	22
9.2 Lens Cleaning.....	22
10. Setup and Interface Guide	22
10.1 Trigger Mode.....	22
10.1.1 External Trigger	22
10.1.2 Self-Timed Trigger	22
10.1.3 Combination of External and Self-Timed Triggers	22
10.2 Communication	23
10.2.1 Communication Disabled.....	23
10.2.2 CS I/O Communication.....	23
10.2.3 RS-232 Communication.....	23
10.2.4 RS-485 Communication.....	24
10.2.5 Concurrent Communication	24
11. Power Calculations and Timings.....	24
11.1 Standalone Operation	24
11.2 Operation with Communication	25
12. Interface Guide for the CR800, CR850, CR1000, or CR3000.....	26
12.1 Memory Setup	26
12.2 Files Manager	27
12.3 CS I/O Communication	27
12.4 RS-232 Port Communication	28
12.5 COM Port (control port) Communication	28
13. Interface Guide for CR510, CR10X, or CR23X.....	28
13.1 Datalogger Requirements	28
13.2 Memory Allocation	28
13.3 PakBus Settings.....	29
13.4 *D15 Settings	29
13.5 Multiple Cameras	29
13.6 Connections.....	29

14. Remote Image Retrieval	29
14.1 LNCMD.EXE	30
14.2 Using LoggerNet File Control	30
14.3 Task Setup / LNCMD.EXE.....	31

15. Installation.....	33
15.1 Enclosures	33
15.2 Camera Mounting Holes	35
15.3 Enclosure Mounting Kit.....	36

Appendices

A. Quick Start.....	A-1
B. DC Heater Kit.....	B-1
C. Troubleshooting.....	C-1
D. Example CRBasic Program.....	D-1

Figures

1. CC640 Camera.....	2
2. Terminal Block Position and Layout	5
3. Insert and Align the Screwdriver to Open the Contact	9
4. Open the Contact.....	9
5. Remove the Screwdriver	10
6. Camera RS-232 to RS-232 Port Connection.....	11
7. Connections for Configuration.....	12
8. Camera CS/IO to Logger CS/IO Connection.....	13
9. Device Configuration Utility Screen.....	15
10. Illustration of Time Stamp Banner.....	19
11. Lens and Filter	21
12. LoggerNet Screen	31
13. LoggerNet File Control Screen	31
14. Task Setup.....	32
15. Task using Add After to Collect Images after Scheduled Call	33
16. The #18543 Enclosure Mounted to a Crossarm.....	34
17. The #18543 Enclosure in the Open Position.....	34
18. The Back of the #18543 Enclosure Showing the Lockable Hasp.....	35
19. Mounting Hole	35
20. Camera Mount to Crossarm	36
B-1. Components of the 26140 Heater Kit.....	B-1
B-2. Heater Properly Placed in the Enclosure.....	B-2
B-3. Field Power Cable Connected to the Camera.....	B-3
B-4. Field Power Cable Connected to the Heater Connector.....	B-3
B-5. Solid State Relay Connections	B-4

Tables

1a. Configuration Cable Connections.....	3
1b. CABLE3CBL Connections	3
2. LED Information at a Glance	7
3. Camera to Datalogger RS-232 Port using #19504	10
4. Camera RS-232 to Datalogger Com Port Connection	11
5. Camera CS I/O Port to Logger CS/IO Port Connection Using #19504 ...	13
6. Explanation of Configuration Settings	16
7. Standalone Operation Power Usages.....	25
8. RS-232 Port File Transfer Times and Power Usage per Image.....	25
9. CR1000 CS I/O File Transfer Times	26
10. CR10XPB CS I/O File Transfer Times	26

CC640 Digital Camera

1. Specifications

Power Supply	
Operating:	9-15 VDC 250 mA Max
Quiescent:	250 uA typical
Operating Temperature	-40°C to +70°C
Ext. Input Signal	
Logic Low Level:	0 - 0.7 VDC (-12VDC Absolute Min)
Logic High Level:	4 - 15 VDC (15VDC Absolute Max)
RS-485	
Max. BAUD Rate:	230.4 KBAUD
RS-232	
Max. BAUD Rate:	230.4 KBAUD
CS I/O	
Max. BAUD Rate:	76.8 KBAUD (keypad only) 57.6 KBAUD (device configuration)
CSDC addresses:	7 or 8
Memory Card Interface	
Type:	CompactFlash
File System:	FAT16
File Type:	JPEG
Size:	Recommended 512 Mb or less
Clock Accuracy	± 1 Minute/Year (0°C to 40°C) ± 4 Minutes/Year (-40°C to 70°C)
Lens	
Mount:	CS-Type
IRIS:	DC Compatible
Resolution	640 x 480 (307,200 pixels) 640 x 504 (with Time Stamp banner)
Dimensions	
Length:	235 mm (9.25 inches) With Lens
Width:	110 mm (4.33 inches)
Height:	64 mm (2.52 inches)
Weight:	0.9 kg (2.0 lbs)
Time to Take Image	~10 seconds
Ships With	manual lens cloth one foot length of #9721 cable interface cables (C1946, and C1947) and screws (4) enclosure mounting screws (3)

2. Introduction

The CC640 digital camera was designed to meet the stringent operational requirements necessary for remote battery powered installations. The CC640 has a very low quiescent power draw and can operate over a wide temperature range.

The camera contains a CompactFlash memory card interface that turns the camera into a powerful image logger. The combination of JPEG compression and memory card storage enables the CC640 to store over 10,000 images.

The CC640 can operate in a stand-alone mode with image acquisitions triggered by the cameras own precision real time clock. The camera can also be connected to a PakBus datalogger. The datalogger can trigger data acquisitions by applying a 5 to 12 Vdc signal.



Figure 1. CC640 Camera

2.1 Connecting

The camera can be connected to the datalogger and power supply using the pigtail cable that comes with the camera (see Table 1a, Configuration Cable Connections). Because of its short length, this cable is typically used for configuration only. Longer cables are usually required for deployment in the field (see Sections 2.1.2 and 2.1.3).

CAUTION

It is essential that the Ground cable be connected first when wiring the camera to the datalogger or the power supply.

Table 1a. Configuration Cable Connections

Colour	Required Connections	Camera Connection
Black	Mandatory—all configurations	Gnd
Red	Mandatory—all configurations	+12V
Green	Optional	Ext
White	N/A	No connection or Ground
Yellow	Optional	RS-485 A or RS-232 TX (Camera Output)
Blue	Optional	RS-485 B or RS-232 RX (Camera Input)
Clear/Shield	Mandatory	Camera Shield Terminal

After connecting the camera to a power source, turn the power switch to the ON position and verify the proper LED sequence (Section 3.7) before connecting the camera for communication.

2.1.1 Standalone Mode

Standalone mode records images to a CompactFlash card installed in the camera and has no connection to a logger. Capturing images in standalone mode requires the use of a FAT16 formatted CompactFlash Memory Card (Section 3.8). The only wire connections to the camera are the power supply wires (ground and +12 V) that connect to a 12 VDC source (see Section 2.1.2).

2.1.2 Power and Pulse Connections

The CABLE3CBL-L cable is typically used to connect the camera to the power source and a datalogger control port (see Table 1b). The datalogger control port is used if the datalogger will trigger image acquisition.

CAUTION

It is essential that the ground cable be connected first.

Table 1b. CABLE3CBL Connections

Colour	Camera Connection	Power Supply or Datalogger Connection
Black	Gnd	G
Red	+12V	12V
Green	Ext	Datalogger Control Port (e.g., C1, C2, C3)
Clear/Shield	Shield	G

2.1.3 Datalogger and MD485 Multiplexer Connections

If the distance between the camera and datalogger will be less than 25 ft (7.6 m), the camera typically connects to the datalogger via the COMCBL1-L cable. Campbell Scientific recommends using the MD485 multiplexer if the distance between the camera and datalogger needs to be more than 25 ft (7.6 m). Detailed information about using the camera with a datalogger or multiplexer is provided in Section 4.

2.2 Configuring

The camera uses PakBus protocol to send image files to the datalogger and both the camera and the datalogger must be configured to enable communication. The RS-232 port is used in conjunction with the Device Configuration software to change settings and operating parameters in the camera (Section 5). Device Configuration Utility is a free download from any Campbell Scientific website.

2.3 Operating

The CC640 is capable of acquiring images in a self-timed mode, an external trigger mode, and by manually taking a picture using the Snap button (Section 3.3). Self-timed mode is set using the Device Configuration Utility (see Section 5). In this mode, the image is stored in a CompactFlash card (see Section 3.8).

The external trigger mode is used with the datalogger. The datalogger triggers image acquisition by applying a 5 to 12 Vdc signal. A pulse port instruction in the datalogger program will apply this signal. An example of a CRBasic pulse port instruction follows:

```
PulsePort (1,1000)
```

A datalogger program that triggers image acquisition is provided in Appendix D.

When taking a picture manually using the Snap button, the power switch needs to be in the ON position. Refer to Section 3.3 for more information.

2.4 Retrieving Images

LoggerNet Version 3.1.3 or newer includes the executable LNCMD.EXE that is required for image file retrieval from dataloggers (Section 14). Images from cameras in standalone mode can be retrieved directly from the CompactFlash Memory Card with a PC that has a CompactFlash socket.

2.5 Additional Reference Material

The CC640 Operating Manual is intended for use by those experienced in working with Campbell Scientific dataloggers. For further information regarding the various uses and applications of the CR800, CR850, CR1000, CR3000, CR510PB, CR10XPB, CR23XPB, MD485, or any additional technology listed in this manual, refer to the appropriate Operating Manuals of these products.

2.6 CC640 Quick Check List

- If interfacing to a datalogger, use a datalogger with the PakBus communication protocol and 2 MB of memory.
- Ensure that the CompactFlash memory card is formatted as FAT16 and not FAT32. (CompactFlash cards purchased from Campbell Scientific are formatted as FAT32, and need to be reformatted as FAT16.)
- Use the Device Configuration Utility to change settings in the camera and other PakBus devices. Datalogger parameters can also be incorporated into the datalogger program or changed with a keyboard display.
- Verify that the lens cable is properly seated, as the connector may inadvertently become unplugged during handling or installation.

NOTE Device Configuration Utility is included in LoggerNet, PC400, and as a free download.

Always place the Power Switch in the Auto Position.

3. Camera Hardware Description

3.1 Terminal Block Connections

NOTE Only shielded cable should be used for connections to the terminal block.

Gnd	Power Ground
+12VDC	9-15VDC Power, 250 mA
Ext.	External Trigger Input, 5.0 Volt Logic Signal, 15Volts Max
RS-485A	RS-485 communication
RS-485B	RS-485 communication
Shield	The shield (drain wire) needs to be connected to this terminal

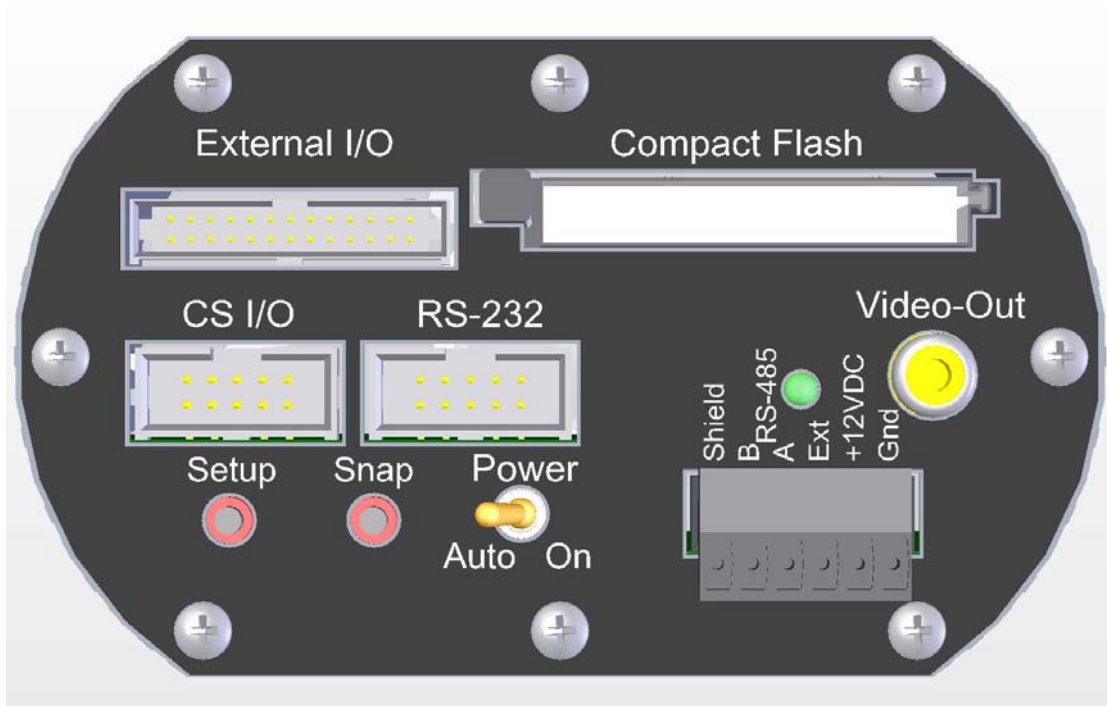

Figure 2. Terminal Block Position and Layout

3.2 Power Switch

The power switch can be used to power the camera continuously on or to place the camera in Auto power mode. The switch should not be left in the On position under normal operation. Leaving the switch in the On position will prevent the camera from entering its low power quiescent mode of operation. The power switch does need to be placed to the On position to perform configuration setup or to focus the camera.

In the Auto position the camera will automatically reduce its power consumption to the low power quiescent mode after an image is acquired. It is recommended to place the switch in the Auto position when images are being triggered by either the external input or the self-timed mode.

3.3 Snap Button

The Snap button is used to manually take a picture. The power switch needs to be set to the On position for the Snap button to operate.

When the Snap button is pressed the LED will slowly flash 2 times, indicating successful initiation of an image acquisition.

3.4 Setup Button

The Setup button performs 2 functions. It toggles the video output on or off and it places the camera in setup mode. The power switch will need to be in the On position for the Setup Button to operate.

When the Setup Button is pressed the LED will slowly flash once.

Pressing the Setup button will force the camera to its default BAUD rate (115,200) on the RS-232 port for about 40 seconds so that the Device Configuration Software can be used to configure the camera. Image acquisitions will also be placed on hold for the same time period. To indicate that the camera is in Setup mode the LED will briefly flash once per second.

If no configuration communication occurs during the 40 seconds, the camera will exit setup mode and resume its normal operating mode. The LED will flash once every 5 seconds.

Pressing the Setup Button will toggle the video output on or off. The video output is used to focus and target the camera in conjunction with a normal television or video monitor. The video output will remain on until the setup button is pressed to toggle it off. The video output will be turned off when the camera enters its quiescent mode, 5 minutes after the camera's power switch has been placed in the Auto position.

3.5 Video Output

The video output connector provides an analogue video signal for the purpose of focusing and targeting the camera. The video output can be configured to NTSC (National Television System Committee) or PAL (Phase Alternating Line) using the Device Configuration Software. NTSC is the standard used in North America and PAL is the standard that is used in most European countries. Consult your monitor owner's manual for display information.

The video output can be turned on and/or off by pressing the Setup Button when the power switch is in the ON position.

During every image acquisition sequence the video output will be momentarily activated when the image is acquired, allowing the operator to view the image that is being captured.

3.6 External I/O Connector

The External I/O connector provides inputs and outputs for operating camera peripherals. Please contact a Campbell Scientific sales representative for details and availability of the CC640 peripherals.

The *Ext.* (External Control) input signal can be used to initiate an image acquisition. An image acquisition can be initiated on demand by applying a voltage pulse to the *Ext.* input. The camera will remain in its quiescent state when the signal to this input remains at logic low (Less than 0.7 Volts). To initiate an image acquisition the input should be pulsed high (4.0 - 15 Volts). The recommended duration of the pulse is between 1ms and 10 seconds. See Section 2.3 for a sample.

Leaving the *Ext.* input signal high for more than 10 seconds will result in another image acquisition starting immediately after the completion of the first.

If the *Ext.* input signal is left in the High state continuously, the camera will not enter its low power mode and images will be acquired on a continuous basis.

The *Ext.* Control Input signal is operated with the power switch in the Auto mode. If the power switch is left in the ON position the LED will flash twice and begin an image acquisition when a positive *Ext* Signal is detected, providing easy confirmation of an externally applied signal.

3.7 LED (Green)

The green LED is intended to provide feedback for the operator. On power up the LED will slowly flash 4 times, indicating that a normal power-on sequence has occurred. If the LED flashes rapidly for several seconds, it means that the camera failed one of the power-on tests. This response is rare and will require that the camera be returned to an authorized repair facility.

The LED will also flash once if the Setup button is pressed and twice if the SNAP button is pressed. During communication or a firmware update the LED will remain ON to indicate a process is in progress that should not be interrupted.

If the power switch is in the ON position the LED should flash once every 5 seconds to indicate that it is running. If the setup button is pressed, the LED will briefly flash once a second to indicate that the camera is ready for setup using the Device Configuration Utility.

Table 2. LED Information at a Glance

LED	
Always Off	The camera has no power connected to it or it is in Quiescent Mode
Quick Flash Every 5 Seconds	The camera is Powered ON (Power switch is in the ON position)
4 Slow Flashes	Normal Power-On Sequence
Rapid Flashes for 4 Seconds	A Power on test did not pass.
Quick Flash Every Second	The camera is in Setup Mode
Steadily On	The camera is carrying out a process that should not be interrupted. This includes acquiring an Image, transmitting an image via communication, or performing a firmware update.

3.8 CompactFlash Memory Card

The camera is equipped to use CompactFlash memory cards. The memory cards must be formatted as FAT16 and not FAT32, since the camera does not support the FAT32 file system. CompactFlash cards purchased from Campbell Scientific are formatted as FAT32, and therefore need to be reformatted as FAT16. When formatting a memory card using a PC, ensure that FAT32 is not selected (FAT16 or just FAT should be used).

Image files are stored on the CompactFlash memory card as JPEG files under the root directory "IMAGES". Each file will be uniquely named with a sequence number (i.e. *E1234567.JPG*).

The CompactFlash card should not be inserted or removed while the camera is in its ON state. Insertion or removal should only be done when the camera is in its quiescent state or when power is removed.

The use of a memory card is optional and is not required for users who use communication to retrieve the images. If a card is present, the camera will write the images to it. Once the memory card is filled, the camera will stop recording images to it until previous files are deleted to create additional image storage space. It is generally recommended to delete older image files from the memory card after downloading them to a permanent storage location.

3.8.1 Firmware Update From Memory Card

CAUTION Failure to properly follow this procedure can result in corruption of the operating system. If this occurs, it may be necessary to send the camera to an authorized repair facility to have the operating system reloaded.

The CompactFlash card is also used to provide a means of updating the camera's embedded firmware. This is done by downloading the appropriate files from any Campbell Scientific website, renaming the new firmware hex file as "NEWCODE.HEX" (all upper case), and placing it in the root directory of the CompactFlash memory card. When the camera powers up and finds the file in the root directory it will begin to update its firmware from the file. The LED will remain continuously on during this process, which may take up to 5 minutes. It is imperative that the power supply is not interrupted during this process. After completion the LED will turn off. Power down the camera, remove the memory card, and delete the "NEWCODE.HEX" file using a PC if no other cameras need to be updated. Leaving the file on the memory card will cause the camera to repeatedly update its firmware every time the camera wakes up from its quiescent mode.

3.9 CS I/O and RS-232 Connections

For configuration and communication, two 10 pin (2 X 5) connectors are built into the camera. The RS-232 port is designed to provide a 9 Pin DCE type port. Part number C1947 provides a DB9 (sockets) connector that can be used for CS/IO and RS-232 operation with the use of the COMCBL1, and configuration with a straight RS-232 cable to the serial port of a pc.

4. Communication

4.1 PakBus Communication

The camera uses the PakBus protocol to send image files from the camera to the datalogger or other PakBus compatible devices.

Communication is not enabled while the camera is in quiescent mode. This is done to conserve power in its low power state. When an image file is ready to be transmitted, the camera will initiate communication and send the JPEG image via the selected PakBus port.

The camera is a PakBus Leaf node and is not capable of performing any routing.

4.2 Connection Kit #19504

For convenience, part number #19504 is used to connect between the camera and the CS/IO port of compatible loggers, or the RS-232 port of the CR800, CR1000, or CR3000 loggers. It consists of a DIN rail mount, a length cable (#17855) with a DB-9 (pins) connector to pigtailed, and some DIN style contacts. The kit mounts in the enclosure and provides a connection between the COMCBL1-L and the #17855. See Figures 3, 4, and 5 below to understand how to interconnect the two cables with the #19504. For this connection method, 1 cm of insulation is removed from the wire to be inserted into the DIN style connectors. The square holes and round holes are arranged in pairs and the square hole associated with its corresponding round hole opens the contact in the round hole where the wire is inserted. The round hole closest to a square hole is a square hole/round hole pair.

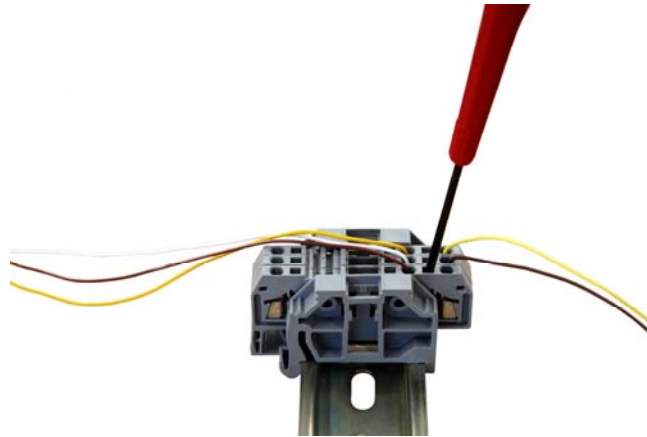

Figure 3. Insert and Align the Screwdriver to Open the Contact

The screwdriver supplied with the camera is used with the #19504. Align the screwdriver by lightly inserting it in the square opening and at the angle shown. This also points to the round hole paired with that square hole. “Feel” the flat of the screwdriver meet the “flat” of the contact by turning lightly as the screwdriver is positioned.

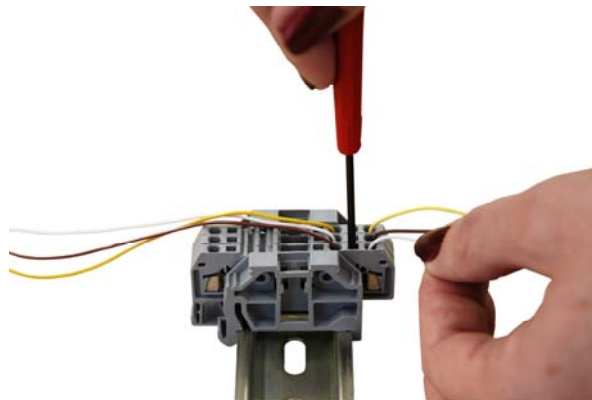

Figure 4. Open the Contact

When the screwdriver is aligned, push the screwdriver in while moving the screwdriver to the position shown. You’ll feel pressure against the screwdriver as it is opening the contact. The screwdriver will bottom out and will stay in place so that wires can be inserted or removed as needed.

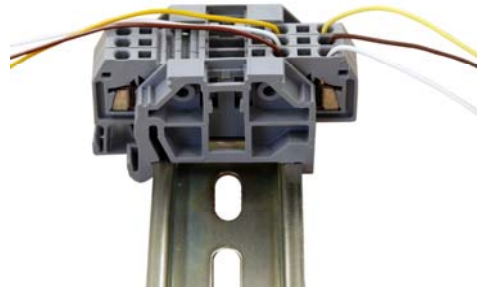

Figure 5. Remove the Screwdriver

When the screwdriver is removed, the contact closes holding the wire in place.

4.3 RS-232 Port

The RS-232 port provides an RS-232 communication port for transmitting image files to a datalogger using the PakBus Protocol, and configuring the camera.

Table 3. Camera to Datalogger RS-232 port using #19504	
RS-232 connection 9 pin to 9 pin	
COMCBL1-L	#17855
YL	YL
WH	BN
BN	WH

Camera data cable junction terminals Logger RS-232 port
 C1947-----> COMCBL1-> #19504 contact kit--->#17855 (SC110)

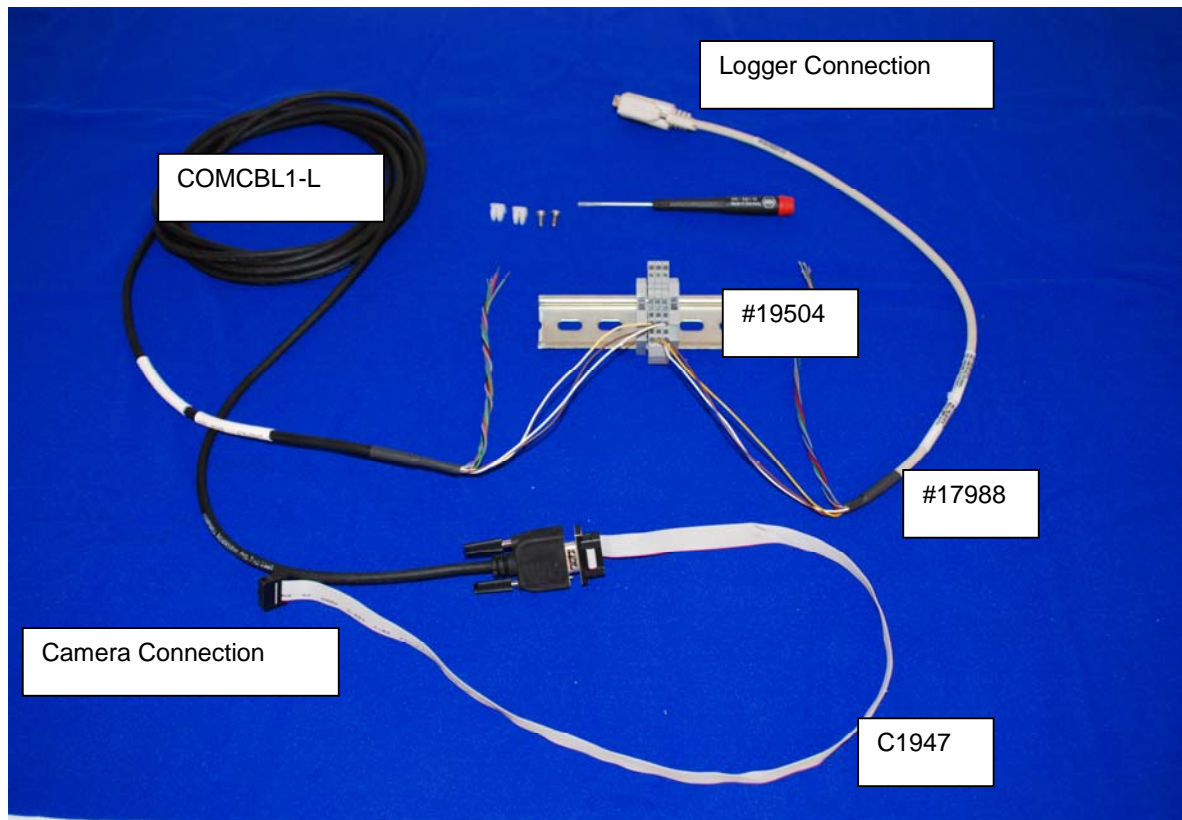

Figure 6. Camera RS-232 to RS-232 Port Connection

It's also possible to use RS-232 protocol via the control ports of CR800, CR1000 and CR3000 loggers. The connection is listed below.

Table 4. Camera RS-232 to Datalogger Com Port Connection	
RS-232 connection 9 pin to pigtails	
COMCBL1-L	Pigtails to logger control ports
YL	G
WH	Even # control port
BN	Odd # control port

Camera data cable logger control ports
 C1947-----→ COMCBL1-----→

If the recommended cable is used, the RS-232 can be used at distances up to 30 metres (98.1 feet). Longer lengths or different cables may require that the BAUD rate be set slower than the default 115200 BAUD.

The RS-232 port is used in conjunction with the Device Configuration software to change settings in the camera such as the PakBus addresses. Figure 7 illustrates the connections required for interfacing to a computer. A straight cable is used. Configuration is more conveniently accomplished at a test bench prior to installation

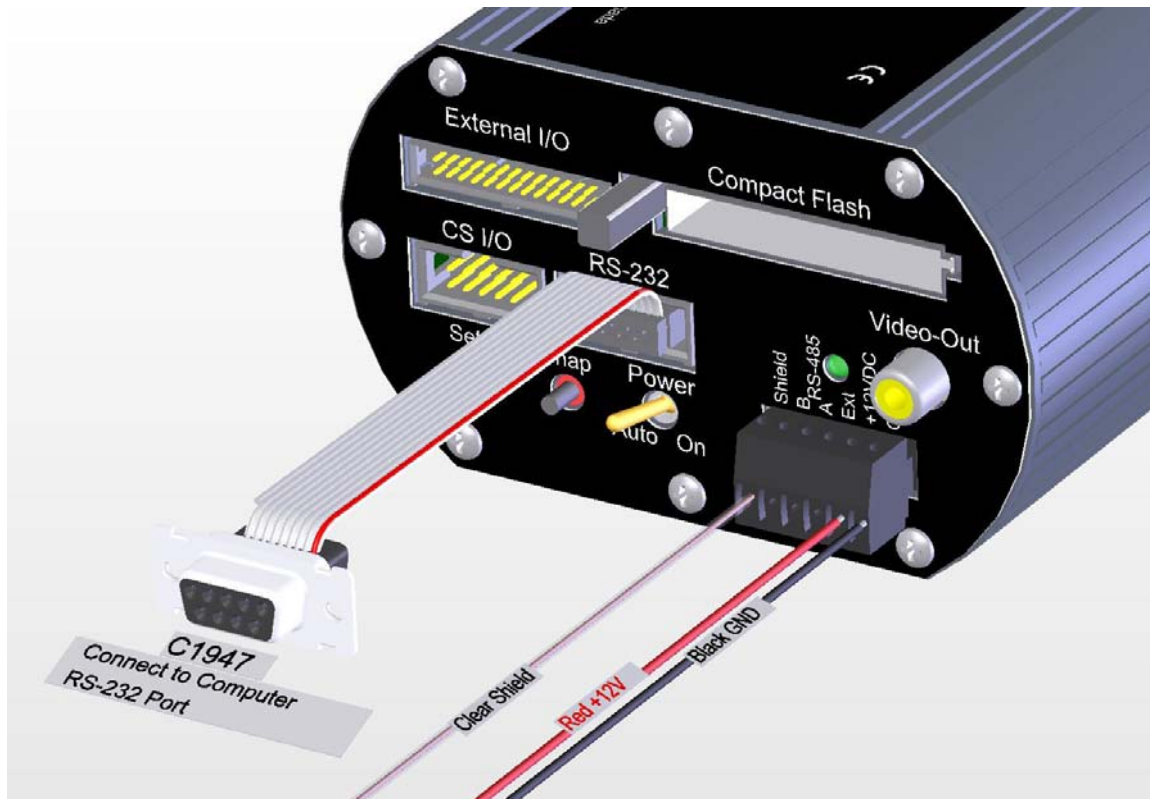

Figure 7. Connections for Configuration

4.4 CS I/O Port

The CS I/O port on the camera provides a connector for CS I/O communication. The port is designed to communicate with Campbell Scientific dataloggers equipped with CS I/O communication ports. A ribbon cable assembly (C1947) is used to provide a male 9-pin connector that can plug directly to the CS I/O port or to an SC-12 cable that connects to the CS I/O port. The CS I/O port is used to download image files to the datalogger. The image files can then be collected remotely in conjunction with the regular data.

The camera will support only Concurrent Synchronous Device Communication (CSDC) and will not support Modem Enabled (ME) Communication. The camera can be assigned one of two CSDC addresses, 7 or 8. If another CSDC device is connected to the CS I/O port, then the camera must have an address that is different from the other device.

The CS I/O port cable lengths should be restricted to 3.65 metres (12 feet) or less to insure reliable operation.

Table 5. Camera CS/IO Port to Logger CS/IO Port Connection Using #19504	
CS/IO connection 9 pin to 9 pin	
COMCBL1-L	#17855
WH	WH
BN	BN
RD	RD
GN	GN
BL	BL
GY	GY

Camera data cable junction terminals Logger CS/IO port
 C1947-----> COMCBL1-> #19504 contact kit---> #17855 (SC110)

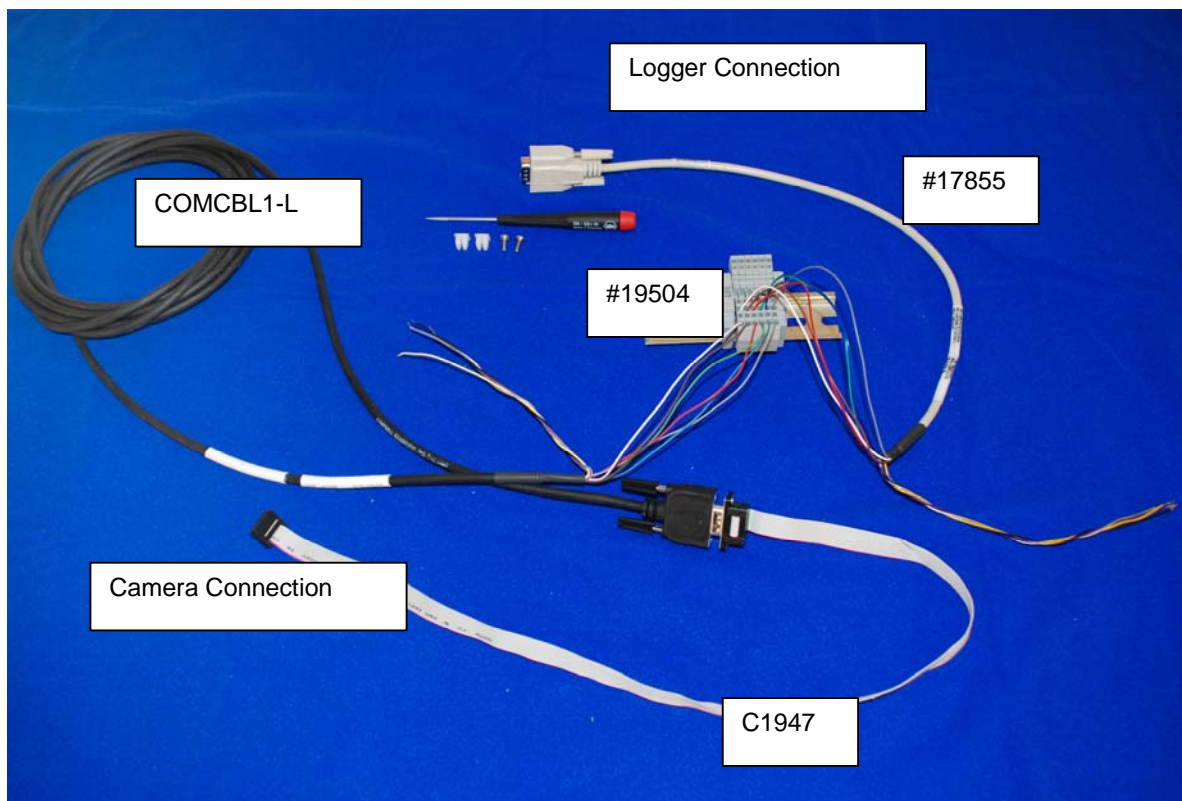

Figure 8. Camera CS/IO to Logger CS/IO Connection

4.5 RS-485 Port

The RS-485 terminals can be used in conjunction with the MD485 to interface a datalogger to the camera over distances of up to 1219 metres (4000 feet). The +12V GND and EXT control lines cannot be practically run these long distances. Normally the RS-485A and RS-485B lines, and an additional ground connection, are run these distances. Refer to the MD485 manual for additional information.

5. Device Configuration Utility

The Device Configuration Utility can be used to set the clock on the camera as well as other operating parameters such as the PakBus addresses.

Using The Device Configuration Utility

- Connect an appropriate power supply to the camera.
- Connect the RS-232 cable to the camera and the computer.
- Turn the Power switch to the "ON" position.
- Press the Setup Button (this temporarily forces the RS-232 port to 115KBAUD).
- Within 40 Seconds invoke the Device Configuration Utility (Figure 10).
- Select CC640 as the device and connect to the camera.
- Table 6 offers further information on configuration settings.

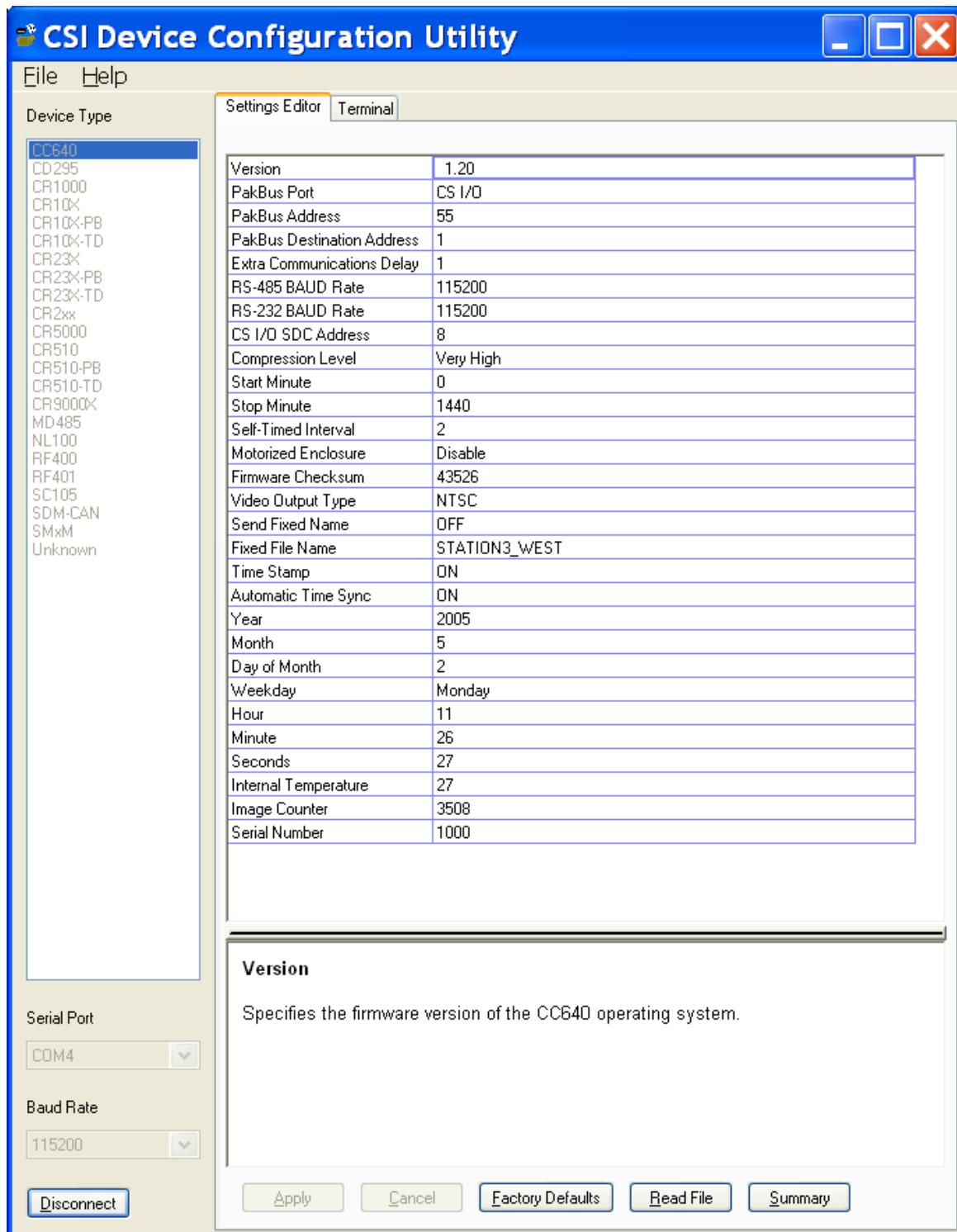

Figure 9. Device Configuration Utility Screen

Table 6. Explanation of Configuration Settings

Parameter	Type	Description	Default Value
Version	Read Only	The firmware version of the CC640 operating system	N/A
PakBus Port	Read/Write	Options: NONE, CS I/O, RS-485, RS-232 Only select a PakBus Port if communication is being used to transfer images via PakBus.	NONE
PakBus Address	Read/Write	Options: 1 – 4094 A PakBus Address should be assigned to the camera for PakBus Communication.	55
PakBus Destination Address	Read/Write	Options: 1 – 4094 This is the PakBus address of the destination device where the image files will be transmitted. The device is normally a Campbell Scientific datalogger.	1
Extra Communication Delay	Read/Write	Options: 0 – 10 Seconds Additional Delays can be added for PakBus networks with long propagation delays.	1
RS-485 BAUD rate	Read/Write	Options: 230400, 115200, 76800, 57600, 38400, 28800, 19200, 9600, 1200	115,200
RS-232 BAUD rate	Read/Write	Options: 230400, 115200, 76800, 57600, 38400, 28800, 19200, 9600, 1200	115,200
CS I/O SDC ADDRESS	Read/Write	Options: 7 or 8 If other CSDC devices are connected to the same CS I/O port, each device must have its own address.	8
Compression Level	Read/Write	Options: Very High, High, Medium, Low, None This option selects the amount of compression to be applied to the JPG files. Higher compression levels result in smaller files but the images will lose subtle details. Selecting none will produce a large sized (480Kb) Lossless image.	High
Start Minute	Read/Write	Options: 0-1339 If the camera is in a Self-Timed Mode, this parameter allows a start time from Midnight to be selected.	0
Stop Minute	Read/Write	Options: 0-1440 If the camera is in a Self-Timed Mode, this parameter allows a stop time from Midnight to be selected.	1440
Self-Timed Interval	Read/Write	Options: 0-1440 If this parameter is non-zero then the camera will automatically wake itself up and acquire images based on the interval entered.	0
Motorized Enclosure	Read/Write	Options: Disable, Enable Select enable if the ENC-CC motorized covered enclosure is used. It is important to select disable if the motorized enclosure is not used. Selecting enable when a motorized enclosure is not present will slow down the operation of the camera.	Disable
Firmware Checksum	Read Only	This is the checksum calculated from the firmware present on the camera.	N/A

Video Output Type	Read/ Write	Options: NTSC, PAL NTSC video is the North American Standard. PAL is the VIDEO standard for most European Countries.	NTSC
Send Fixed Name	Read/ Write	Options: ON, OFF If set to off, then the camera will send each image with a unique file name. The format will be AAAA_XXXXXXX.JPG Where AAAA is the camera's PakBus Address and XXXXXX is the Image Counter value. If Send Fixed Name is on, then the image will always be sent with the same name. The name used will be the text entered in the Fixed File Name string followed by the JPG extension.	OFF
Fixed File Name	Read/ Write	Options: ON, OFF An optional fixed name that can be used for naming the JPEG files that are transferred from the camera. The name must be less than 16 characters. The JPG extension will be added to this name The PakBus address of the camera will still be placed in front of the filename. This Name Field will also be placed on the IMAGE if the Time Stamp is enabled.	OFF
Time Stamp	Read/ Write	Options: OFF, Bottom, Top, Inside Top A date and time stamp will be placed on the image if a setting other than OFF is selected. The Top and Bottom options include the text entered in the Fixed File Name field as well. The images with Top and Bottom time stamps will be 640x504 pixels with the text added to the bottom- or top-most 24 pixel rows. The Inside Top time stamp will remain a 640x480 image but only the date and time will be placed in the top left corner of the picture.	CC640
Automatic Time Sync	Read/ Write	Options: ON, OFF If set to on, the camera will attempt to update its clock automatically from the selected PakBus Destination Address.	OFF
PakBus Security Code	Read/ Write	The security code for a destination address with security enabled. A default of zero is required when security is not enabled.	0
Year	Read/ Write	Options: 2004 - 2104	N/A
Month	Read/ Write	Options: Jan - Dec	N/A
Date	Read/ Write	Options: 1-31	N/A
Weekday	Read/ Write	Options: Sun. – Sat.	N/A
Hour	Read/ Write	Options: 0 – 23 In 24 Hour Format Only	N/A
Minute	Read/ Write	Options: 0-59	N/A
Second	Read/ Write	Options: 0-59	N/A
Temperature	Read Only	Temperature in Degrees Celsius -55 to +125. Temperatures beyond the operating temperature range are not recommended.	N/A

Image Counter	Read/ Write	Options: 0 – 9999999 (7 Digits) The file counter can be changed if desired. The file counter will loop back to zero after 9999999.	1
Serial Number	Read Only	Serial Number	N/A

6. Operational Description

6.1 Self Timed Mode

In self-timed mode the camera is capable of waking itself up and acquiring an image. In order to place the camera in self-timed mode, use the Device Configuration Software to set the *Self-Timed Interval* parameter to non-zero.

Self-Timed Example 1:

To take a picture every 15 minutes starting at Midnight the self-timed mode parameters should be set as follows:

Start Minute: 0
Stop Minute: 1440
Self-Timed Interval: 15

Self-Timed Example 2:

To take a picture every Hour starting at 4:00AM and ending at 11:00PM the self-timed mode parameters should be set as follows:

Start Minute: 240 (4 hours * 60 Minutes)
Stop Minute: 1380 (23 Hours * 60 Minutes)
Self-Timed Interval: 60

6.2 External Trigger Mode

An image acquisition can also be triggered from the Ext. Input Signal on the camera. It is recommended that a short pulse be used to initiate the image acquisition. If a positive voltage is applied and not removed before the image acquisition sequence is complete, the camera will begin another image acquisition immediately after. An image acquisition can be as short as 10 Seconds. See Section 2.3 for a program example.

NOTE External Trigger Mode can be used in conjunction with the Self-Timed Mode by following all the steps as listed in this section.

7. Image Quality

7.1 Lighting Conditions

Lighting conditions have the greatest influence on image quality. The CC640 camera produces the best images under normal daylight conditions. Pictures taken in good daylight conditions produce crisper and brighter images.

The CC640 uses the entire image to adjust the exposure settings for a particular scene. Scenes that contain small variations in light intensities will produce better

images also. In scenes with high variations in light intensities, such as a bright sky and a dark horizon, the image may contain portions that are under-exposed and portions that are over-exposed. The CC640 utilizes various techniques to produce an overall good picture under most lighting conditions.

When the CC640 is over-exposed by an overly bright object, such as the sun in a sky shot, the over-exposed object may begin to turn black. This is a result of the CMOS image sensor being over-exposed to light and becoming saturated. It is normal operation for the centre of the Sun to appear black under certain lighting conditions.

7.2 Night Time Images

The camera does not produce distinguishable images at night time. If lighting is present (such as street lights), then objects may become noticeable.

7.3 Date and Time Stamp

Setting the Time Stamp option of the camera to ON will add a banner to the bottom of the images (Figure 10). The banner adds 24 pixel rows to the image and increases the size of the image from 640x480 to 640x504 pixels.

The banner includes the text entered for the fixed file name. The text that can be displayed includes numbers 0-9, letters A-Z (converted to upper case), and an underscore symbol. Unsupported symbols/characters are displayed as a space.

Following the fixed file name string is the Date and time stamp. The First 3 characters are used for the month followed by the day of month and year. The time is HH:MM in 24 hour clock format.

The banner ends with the internal camera temperature displayed in degrees Kelvin. This is intended for diagnostic purposes. The temperature is displayed in degrees Kelvin so that there is no confusion that the temperature represents some ambient temperature. The temperature is internal and can vary substantially from the actual ambient temperature. To convert the temperature to degrees Celsius subtract 273 from the value displayed.



Figure 10. Illustration of Time Stamp Banner

7.4 JPEG Compression

There are 5 selectable levels of JPEG compression:

- Very High (32 Kbytes Typical)
- High (48 Kbytes Typical)
- Medium (72 Kbytes Typical)
- Low (100 Kbytes Typical)
- None (Lossless) 480 Kbytes Typical

NOTE

These are typical values with the time stamp enabled on the image (640x504 pixels). The size of the images varies with the image content.

Selecting **None** will produce the best quality JPEG files with Lossless compression. Lossless compression does not introduce additional distortions and every pixel is the same size as in the original image. Very High compression will produce the smallest files but with the most degradation of the image.

Small files may be important for slow telecommunication links or for applications that require a large number of pictures to be stored onto the memory card.

Very high compression is the recommended setting to produce satisfactory results for most applications while taking advantage of the benefits of smaller file sizes.

8. Lens

The standard Lens for the CC640 camera contains the following features:

- CS Mount
- Varifocal (manual zoom)
- Manual Focus
- DC Iris

The camera controls the iris of the lens using the cable with a 4-pin connector. This connector must always be plugged into the receptacle (on the front lens plate of the camera) for proper operation.

8.1 Focus and Zoom Adjustment

The lens is equipped with manual zoom and focus adjustment rings. The most practical way to adjust the lens is by utilizing a normal Television monitor or a portable Television.

- Connect an appropriate video cable from the video output connector (RCA Jack) of the camera to the video input on the video monitor of the television.
- Turn the power switches of both the camera and the television to the ON position and then press the Setup Button. Within a few seconds the video will appear on the monitor. Consult your monitor owner's manual for additional instructions on displaying video from the video input jack.

- Once the video is observed on the monitor, loosen the 2 thumbscrews on the adjustment rings of the lens.
- It is easier to adjust the zoom first and then the focus.
- Once the zoom is adjusted as desired tighten the thumbscrew so that the zoom will not inadvertently move when the focus is adjusted.
- Adjust the focus ring and then tighten its thumbscrew as well.

Recommendation: If the camera is targeted at an object that is far away (100 metres or more), it may be beneficial to adjust the lens before taking the camera into the field by using an object that is at a similar distance away. It is much easier to use a larger monitor in an office environment, rather than a portable TV at the installation site, as sunlight tends to make it difficult to view a television screen outdoors.

8.1.1 Temperature Variations and Focus

The CC640 can operate under extreme temperature variations. The focus of the lens can change slightly with large variations in temperature. For example, if a lens is focused at +25°C the lens may be slightly out of focus at -30°C. The change in focus will be less noticeable if the focus is adjusted closer to the camera's operating temperature.

8.2 Lens Filter

The CC640 camera is equipped with an IR cut filter on its lens. This is threaded onto the front of the lens and is required to filter out near-infrared light that can have an undesirable affect on the images. It is recommended that the filter always be left installed on the lens.

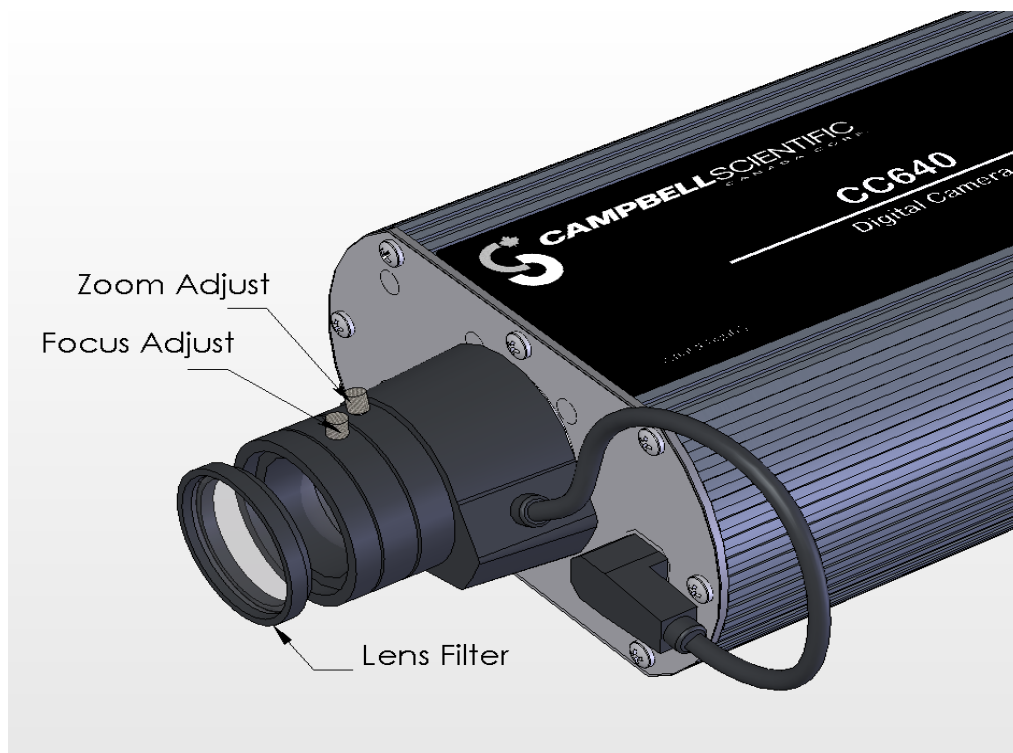

Figure 11. Lens and Filter

9. Maintenance

The CC640 requires little maintenance and no calibrations. Keeping the camera clean and in a dry environment is important for the longevity of the camera.

9.1 Lithium Battery

The Camera is equipped with a Lithium Thionyl Chloride Battery. The battery maintains the clock functionality for periods when power is not connected to the camera. The expected battery life is 2 years. If the camera is in operation and connected to a power supply, the battery life may be extended up to 10 Years.

It is recommended that the battery be replaced by a certified repair facility. The sticker on the bottom of the camera indicates the date of battery installation.

9.2 Lens Cleaning

If the filter or lens requires cleaning, it is very important that only a proper lens cloth (like those included with your CC640 camera) or lens tissue be used. The use of inappropriate materials to clean the lens can permanently damage or reduce the effectiveness of the filter or lens.

10. Setup and Interface Guide

10.1 Trigger Mode

Determine how the camera will be triggered to initiate an image acquisition. There are 2 different trigger sources. The first is using the external trigger input and the second is self-timed mode, which uses the cameras own real time clock. A combination of external trigger and self-timed mode can be used also.

10.1.1 External Trigger

If the camera is being triggered by an external signal provided by another device then:

- Set the parameter *Self-Timed Interval* to zero
- Connect the external signal to the *Ext* input of the camera

10.1.2 Self-Timed Trigger

A camera that is used in self-timed mode should be set up as follows:

- Set the parameter *Self-Timed Interval* to a non zero value
- Change the *Start Minute* and *Stop Minute* values accordingly
- Leave the *Ext* input of the camera unconnected or connected to ground

10.1.3 Combination of External and Self-Timed Triggers

A camera that is used in this configuration should be set up as follows:

- Set the parameter *Self-Timed Interval* to an non zero value
- Change the *Start Minute* and *Stop Minute* values accordingly
- Connect the external signal to the *Ext* input of the camera

10.2 Communication

Communication can enable remote retrieval and/or storage of images to external devices such as compatible Campbell Scientific dataloggers. The PakBus protocol is used to transfer the images.

10.2.1 Communication Disabled

When a camera is not connected to other devices for communication then it is important to:

- Set the parameter *PakBus Port* to None

10.2.2 CS I/O Communication

The camera can download images to a compatible Campbell Scientific datalogger via the CS I/O port. The following items are required for CS I/O PakBus communication:

- Set the parameter *PakBus Port* to CS I/O
- Set the parameter *PakBus Address* to a unique value in the PakBus network.
- Set the parameter *PakBus Destination Address* to the datalogger that is intended to store the images.
- Insure that the parameter *CS I/O CSDC ADDRESS* of the camera is unique among the peripherals that are connected to the dataloggers' CS I/O port.
- Connect the camera CS I/O port to the datalogger using the supplied ribbon cable adapter.
- Insure that the datalogger CS I/O BAUD rate is set to 76.8 KB or less

Refer to 4.4 for connections required when using the CS I/O port.

NOTE

The camera must always have +12Volts power connected to it when connected to the CS I/O port of a datalogger. Failing to apply power to the camera will prevent other devices from communicating with the datalogger.

10.2.3 RS-232 Communication

The camera can download images via its RS-232 port using the PakBus protocol. The following items are required for RS-232 PakBus communication:

- Set the parameter *PakBus Port* to RS-232
- Set the parameter *PakBus Address* to a unique value in the PakBus network.
- Set the parameter *PakBus Destination Address* to the device that is intended to retrieve the images.
- Set the *RS-232 BAUD rate* to match the BAUD rate of the device being connected to the camera.

Refer to Section 3 for additional information and connections diagrams using the RS-232 port.

10.2.4 RS-485 Communication

The camera can download images via its RS-485 port using the PakBus protocol. An MD485 can be used to transmit images via PakBus from a camera to other devices:

- Set the parameter *PakBus Port* to RS-485
- Set the parameter *PakBus Address* to a unique value in the PakBus network.
- Set the parameter *PakBus Destination Address* to the device that is intended to retrieve the images.
- Set the *RS-485 BAUD rate* to match the BAUD rate of the RS-485 network that the camera is being connected to.

Refer to Section 4.5 for additional information on the RS-485 port.

10.2.5 Concurrent Communication

PakBus allows the camera to download images to a datalogger simultaneously with other datalogger communication. A communication task will take longer if the datalogger is communicating with multiple devices at the same time.

It may be beneficial to set up the system to avoid image transfers when other communications are scheduled.

For example, longer connect times on long distance telephone connections can be avoided by scheduling image transfers from the camera to the datalogger outside the scheduled data collection time. If a station is called on the hour to retrieve data, image acquisitions could be initiated before the scheduled call (15 minutes prior) to shorten the connect times.

11. Power Calculations and Timings

The CC640 was specifically designed for operation in power-constrained systems such as solar powered sites. It is critical in such systems that the power switch on the camera always be left in the AUTO position to take advantage of the low power mode. This section outlines power consumption of the camera for purposes of power supply design for a system.

11.1 Standalone Operation

In standalone mode the camera operates as a self-contained image logger.

The current draw of the camera while in low power quiescent mode is 250uA. When the camera wakes up to take a picture, operating current draw increases to a maximum of 250 mA for approximately 30 seconds. In order to calculate the daily power usage of the camera, both the quiescent and operating power consumptions need to be calculated.

The quiescent power consumption in Amp-Hours is calculated as follows:

$$P_{\text{quiescent}} = 250 \times 10^{-6} \text{ Amps} * 24 \text{ Hours} = 0.006 \text{ Amp-Hrs} / \text{Day}$$

The operating power usage per picture in Amp-Hours is calculated as follows:

$$P_{\text{operating}} = 0.250 \text{ Amps} * (30 \text{ Sec.} / 3600 \text{ Sec./Hr}) = 0.00208 \text{ Amp-Hrs} / \text{Picture}$$

The daily power usage will depend on the number of pictures taken per day. The power usage can be calculated using the following formula:

$$P_{\text{usage}} / \text{Day} = 0.006 \text{ Amp-Hrs} + (0.00208 \text{ Amp-Hrs} * \text{Number of Pictures Per Day})$$

The following table shows the power usage versus the number of pictures taken per day:

Number of Pictures Per Day	Power Usage Per Day
1 (Every 24 Hours)	0.008 Amp-Hrs
4 (Every 6 Hours)	0.014 Amp-Hrs
12 (Every 2 Hours)	0.031 Amp-Hrs
24 (Every 60 minutes)	0.056 Amp-Hrs
48 (Every 30 minutes)	0.106 Amp-Hrs
96 (Every 15 minutes)	0.206 Amp-Hrs
288 (Every 5 minutes)	0.606 Amp-Hrs
1440 (Every minute)	3.006 Amp-Hrs

11.2 Operation with Communication

If the camera is operating in a standalone mode, the time the camera is operational in this mode is typically 30 seconds. The power calculations are more complicated when communication are involved, as the amount of time the camera is in operating mode is increased by the amount of time it takes for the camera to transfer an image.

The transfer times are influenced by two main factors, the size of the image and the transfer speed used to send the image. The amount of time the camera is on will be increased as the size of the image becomes larger or as the communication rate slows down.

To properly determine the power consumption while communicating, the additional time the camera stays in operating mode needs to be accounted for. The following table is a guideline for determining the amount of time it takes to transfer an image using RS-232 communication.

RS-232 Communication BAUD RATE	Very High Compression (32kB Files)	High Compression (48kB Files)	Medium Compression (72kB Files)	Low Compression (100kB Files)	None Lossless Compression (480kB Files)
9600	47 seconds 0.0053 A-Hrs	71 seconds 0.007 A-Hrs	105 seconds 0.0094 A-Hrs	147 seconds 0.0123 A-Hrs	706 seconds 0.0511 A-Hrs
19200	26 seconds 0.0039 A-Hrs	38 seconds 0.0047 A-Hrs	58 seconds 0.0061 A-Hrs	80 seconds 0.0076 A-Hrs	384 seconds 0.0286 A-Hrs
38400	15 seconds 0.0031 A-Hrs	22 seconds 0.0036 A-Hrs	33 seconds 0.0044 A-Hrs	45 seconds 0.0052 A-Hrs	218 seconds 0.0172 A-Hrs
57600	11 seconds 0.0028 A-Hrs	16 seconds 0.0032 A-Hrs	24 seconds 0.0038 A-Hrs	33 seconds 0.0044 A-Hrs	160 seconds 0.0132 A-Hrs
115200	8 seconds 0.0026 A-Hrs	12 seconds 0.0029 A-Hrs	18 seconds 0.0033 A-Hrs	25 seconds 0.0038 A-Hrs	120 seconds 0.0104 A-Hrs

Table 9. CR1000 CS I/O File Transfer Times

CR1000 CS I/O Communication BAUD RATE	Very High Compression (32kB Files)	High Compression (48kB Files)	Medium Compression (72kB Files)	Low Compression (100kB Files)	None Lossless Compression (480kB Files)
9600	40 seconds 0.0049 A-Hrs	60 seconds 0.0063 A-Hrs	90 seconds 0.0083 A-Hrs	125 seconds 0.0108 A-Hrs	600 seconds 0.0438 A-Hrs
19200	23 seconds 0.0037 A-Hrs	34 seconds 0.0044 A-Hrs	51 seconds 0.0056 A-Hrs	71 seconds 0.007 A-Hrs	342 seconds 0.0258 A-Hrs
38400	14 seconds 0.0031 A-Hrs	21 seconds 0.0035 A-Hrs	31 seconds 0.0042 A-Hrs	43 seconds 0.0051 A-Hrs	209 seconds 0.0166 A-Hrs
57600	11 seconds 0.0028 A-Hrs	16 seconds 0.0032 A-Hrs	24 seconds 0.0038 A-Hrs	33 seconds 0.0044 A-Hrs	160 seconds 0.0132 A-Hrs
115200	Do not use	Do not use	Do not use	Do not use	Do not use

Table 10. CR10XPB CS I/O File Transfer Times

CR10XPB-2M CS I/O Communication BAUD RATE	Very High Compression (32kB Files)	High Compression (48kB Files)	Medium Compression (72kB Files)	Low Compression (100kB Files)	None Lossless Compression (480kB Files)
76800	49 seconds 0.0055 A-Hrs	74 seconds 0.0072 A-Hrs	111 seconds 0.0098 A-Hrs	154 seconds 0.0128 A-Hrs	738 seconds 0.0533 A-Hrs

The communication transfer times indicated in the above tables do not include the 30 seconds that it takes for the camera to acquire the image. These times can be used to determine the additional power used by the datalogger to receive the image. The power usage numbers, however, do include the additional 30 seconds of on time for the camera.

12. Interface Guide for the CR800, CR850, CR1000, or CR3000

This section contains information for interfacing the CC640 camera to the CR800, CR850, CR1000, or CR3000 datalogger. The datalogger and the CC640 both have several different types of communication ports. This provides different interface options for the user. This includes using the CS I/O port, the 9 Pin RS-232 Serial Port, the control COM ports (1-4), and RS-485 if using an MD485 interface.

12.1 Memory Setup

To facilitate the storage of images a CFM100 allows the use of a CompactFlash card on the CR1000 or CR3000; the CFM100 is not compatible with the CR800 and CR850. With the CR800 and CR850, memory is allocated from the datalogger's internal memory by creating a virtual user drive "USR:". Our CR1000 and CR3000 dataloggers can also use this memory allocation method. With this method, you enter a non-zero value for the parameter "USR: drive size" to allocate internal memory for the drive. The amount of memory required will vary depending on each application. A good number to start with is 524288 bytes.

The following methods can be used to set the drive size of the USR:

- The Device Configuration Utility program
- PakBus Graph
- Editing the parameter from the Status Table
- The datalogger's optional keypad and display.

12.2 Files Manager

The Files Manager setting on the datalogger facilitates the management of JPEG files that are received from the camera. The Files Manager allows the user to specify a name for the files and the number of files kept in a ring memory type fashion.

The format of the Files Manager setting is as follows:
(AAAA,DDD:NAME.EXT,NNNN)

- AAAA – Is the PakBus address of the camera
- DDD – Is the destination drive on the datalogger
USR for the user drive
CRD for the CompactFlash memory card
- NAME – Is any name string that will be used to name the files
- EXT – The file extension of the incoming file must match. In the case of the camera this must always be “JPG”.
- NNNN – The number of files kept in the ring memory. This number should be low enough so that the memory required for the files is less than what is available in the corresponding drive. However, for the internal USR drive this would normally be between 3 and 10 images and for CRD drive (memory card) this can be larger. When communications are used to retrieve images, it is suggested to limit the number of files in the ring memory to 200 in order to avoid long communication delays.

An example Files Manager setting is as follows:
(55,USR:SkySouth.JPG,3)

- Camera PakBus address is 55
- The files will be stored in the USR: director with a name SkySouth####.JPG where #### is an incrementing number. Entering a zero for this parameter will disable the automatic numbering and produce a fixed file name.
- The 3 most recent files will be kept. A new incoming file will cause the oldest to be deleted.

12.3 CS I/O Communication

The camera can connect directly to the CS I/O port to transfer images to it. In addition to setting up the Memory (refer to Section 12.1 Memory Setup) and the Files Manager (refer to Section 12.2 Files Manager) the datalogger's SDC7 and SDC8 BAUD rates must be changed from the default 115200 BAUD to 57600 BAUD.

If desired, a control port on the datalogger can be configured to pulse a control port that is connected to the Ext. Input of the camera to initiate image acquisitions.

Refer to 4.3 for a discussion of the connections between the camera and the datalogger CS/IO port.

12.4 RS-232 Port Communication

The camera can be connected to the 9 pin RS-232 port of the datalogger. Section 4.2 describes the connection kit #19504 to make the connection.

The camera can be left at its default RS-232 BAUD rate of 115200. *Table 3. Camera to Datalogger RS-232 port* illustrates the camera connection required for interfacing to the datalogger.

12.5 COM Port (control port) Communication

On the CR800, CR850, CR1000, and CR3000, the control ports can be configured to function as RS-232 communication ports. Any of these COM ports can be configured as PakBus ports and used to communicate with the camera.

The COM ports can be activated as PakBus ports using the Device Configuration utility or by using the SerialOpen instruction in the CR1000 program. The following SerialOpen instruction configures COM port 2. (BAUD rate 115200, PakBus Port - 4, transmit delay - 0, Buffer size - 1000.

```
SerialOpen (Com2,115200,4,0,1000)
```

Refer to Section 4.3 for a discussion of the RS-232 COM port connections.

13. Interface Guide for CR510, CR10X, or CR23X

This section contains information for interfacing the CC640 camera to a CR510, CR10X, or CR23X datalogger. The CC640 camera can interface to the datalogger via the CS I/O port directly or through an MD485 interface.

13.1 Datalogger Requirements

The datalogger needs to be a 2 MB datalogger. The datalogger must also contain the PakBus operating system to support the communication and file storage capabilities.

13.2 Memory Allocation

Memory must be allocated in the datalogger for the purpose of storing files. The memory is allocated in multiples of 64 KB blocks. Memory allocated for file storage comes out of final storage space. The files are stored in a circular buffer (ring memory). When new files are sent from the camera to the datalogger's final storage memory the oldest files will be deleted to make room for the new file.

The memory can be allocated as follows:

- Enter *D16A
- 16:XX should be displayed. XX represents the number of 64 Kbyte memory blocks allocated for file storage.
- Enter the number of blocks required followed by A. (Recommend 6 to 16 blocks for a 2 MB logger)

The number of memory blocks required will vary with the compression level selected and the number of files required to reside in the dataloggers final storage. It is recommended to allocate between 6 to 16 memory blocks. If the compression level selected is none then 16 memory blocks (1024 kbytes) is recommended. Files can exceed 500 Kbytes with None selected as compression.

13.3 PakBus Settings

PakBus communication facilitates the transfer of images from the camera to the datalogger. Several parameters must be set on the datalogger to enable PakBus communication with the Camera.

These parameters can be set either with a datalogger keyboard display, using *Edlog \ Options \ PakBus Settings*, or with the Device Configuration Utility using Terminal Emulator mode.

13.4 *D15 Settings

The *D15 settings are used to set the PakBus parameters necessary for communication with the camera. Refer to PakBus Networking Guide for additional information on PakBus and these settings. If values for parameters 01, 02, 03 are too small, you may not be able to connect to all network nodes.

- *D 13:00
- 15A 15:???? – PakBus Address (prefer 1) must match the destination PakBus address of the camera setting.
- A 01:0000 –The Max number of Nodes recommend 3 or more
- A 02:0000 –The Max number of neighbours recommend 3 or more.
- A 03:0000 –The Max number of routers recommend 3 or more.
- A 04:0000 – Default router recommend to leave at zero

13.5 Multiple Cameras

Multiple cameras can be placed on a single datalogger. However, the system should be configured so that image transfers to the datalogger from more than one camera do not occur at the same time. If a collision does occur, images will not get stored onto the datalogger. Each camera attached to the logger has to have a different PakBus, and CSDC address.

13.6 Connections

The Ext. connection is optional if the camera is set up in self-timed mode. The CS I/O cable length between the camera and the datalogger is limited to 3.65 metres (12 feet) or less.

Refer to 4.4 for connections to the CR510, CR10X, or CR23X.

14. Remote Image Retrieval

Once the camera has transferred an image to a datalogger, LoggerNet communication can be used to retrieve the image remotely from the datalogger memory. For practical purposes it is recommended that the communication link used for image retrieval maintain a speed of 9600 BAUD or more.

14.1 LNCMD.EXE

LoggerNet (Version 3.1.3 or newer) includes the executable LNCMD.EXE that facilitates the image file retrieval from dataloggers. LNCMD.EXE is an executable file that can be used to retrieve images from a datalogger. The file is normally placed in the directory C:\Program Files\Campbellsci\LoggerNet. The current command lines for the LNCMD.EXE executable are as follows:

- List-Stations
 - Lists the names of the stations available to call.
- List-Files <Station>
 - Lists the names of the files stored at a particular station.
- Send-File <Station> <Filename>
 - Sends a particular file to a station.
- Delete-File <Station> <Filename>
 - Deletes a file stored in the datalogger. This is currently not supported on the CR510, CR10X, or CR23X datalogger.
- Retrieve-File < Station > < Filename > <Output Filename >
 - This should be the only command required to collect images with the datalogger. The files sent to the CR10X by the camera have a unique filename by using a counter. To retrieve all images in memory simply use the wildcard character * for the JPG files:
- Retrieve-File <Station> *.JPG
 - This will retrieve files that match the DOS type name entered.
 - Other options for Retrieve_File include Force and NoDateCheck
- Force: Will collect a file even if a file with the same name and date have already been collected.
- NoDateCheck: Will collect a file with the same name only if the date is different.

14.2 Using LoggerNet File Control

Images that are in the dataloggers memory can be viewed or collected on demand by using the File Control feature that is available under the Tools menu of the connect screen. Using the file control can also be useful for debugging purposes.

In the case of the CR510, CR10X, or CR23X datalogger only the CPU device exists where files can be stored. For the CR800, CR850, CR1000, and CR3000, devices can include the CPU, USR and the CRD (CompactFlash module). The devices show up in the left hand side of the File Control panel. To view files of a certain device simply click on the desired device listed in the panel.

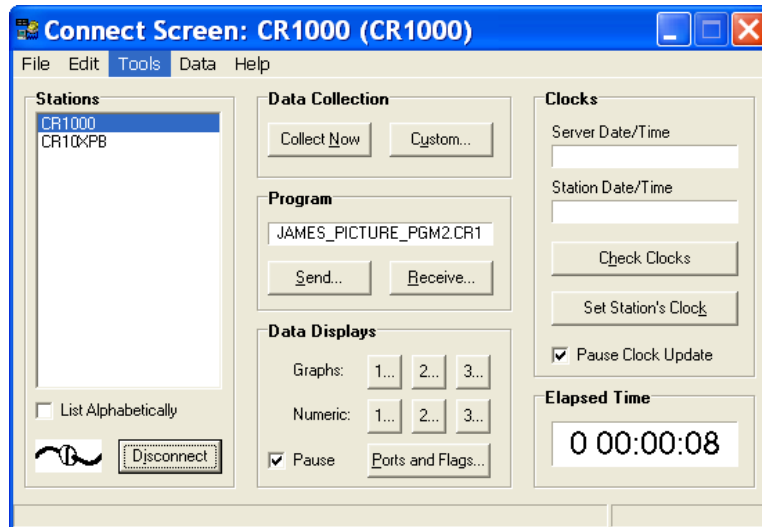

Figure 12. LoggerNet Screen

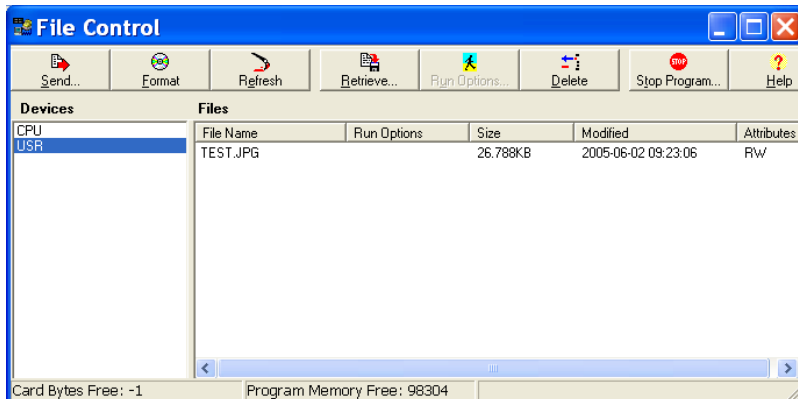

Figure 13. LoggerNet File Control Screen

14.3 Task Setup / LNCMD.EXE

Automated image collection can be achieved by setting up a Task in LoggerNet that executes the LNCMD.EXE executable.

A sample screen of a Task setup that executes LNCMD.EXE is shown in Figure 14 Task Setup. In this example the station CR10XPB is a station that is setup in LoggerNet. The Add Scheduled button can be used to create a task with a programmable schedule. The task shown has the following functionality:

- Task schedule begins at 12:15 and collects images twice an hour at 15 minutes past and 45 minutes past, or every 30 minutes.
- Retrieves images from the station CR10XPB and stores them in the directory C:\Temp_pics
- All files in the CR10X with the extension JPG will be collected. LNCMD.exe will not collect previously collected files unless the Force option is used in the command line.

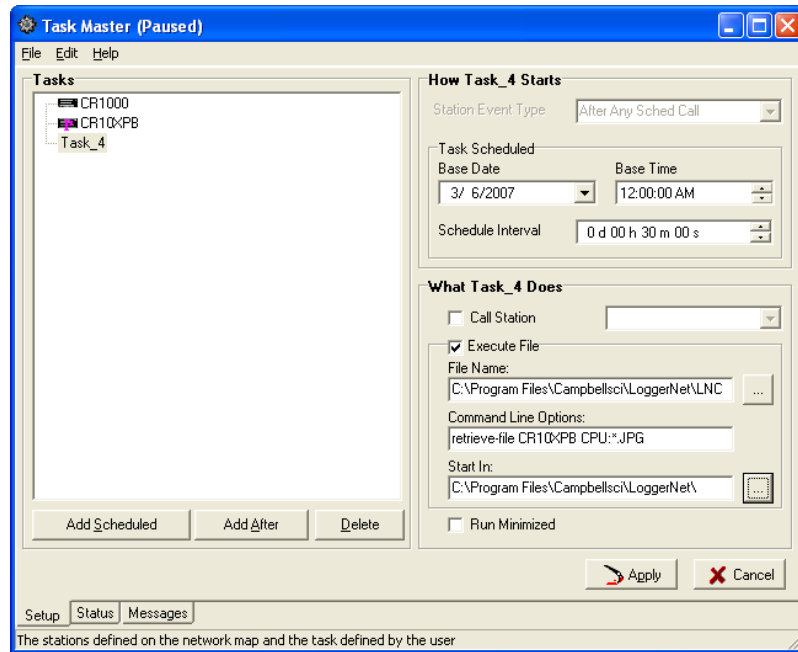

Figure 14. Task Setup

In the above example the task will execute on its own schedule separate from data collection. A task can also be created that calls the LNCMD.EXE after scheduled data is collected. This may be more desirable for stations that are called using a dial up connection to eliminate separate dialling for data and images.

To setup a task that executes after data is collected the desired station would be selected and the Add After option would be selected in the Task Master setup screen. A pull down menu allows various stations event types to be selected. In this case *After Any Sched Call* is selected.

NOTE

In the station setup the parameter Delay Before Hangup should be Non-zero to allow the task to operate.

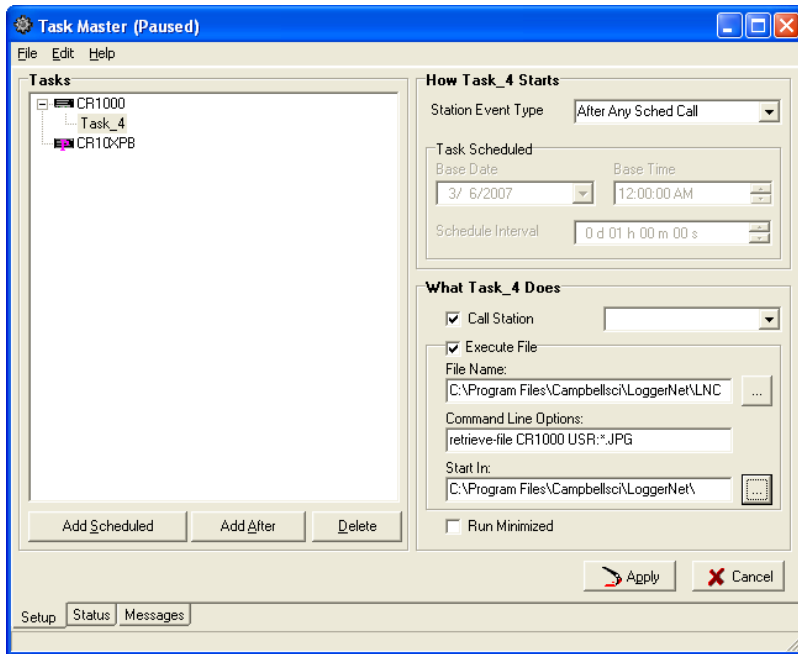

Figure 15. Task using Add After to Collect Images after Scheduled Call

Note that it is necessary to specify the directory in which the files are located for the CR800, CR850, CR1000, and CR3000. In our example the USR: drive is selected. Another option is the CRD: drive if the CompactFlash module is used with the CR1000 or CR3000.

15. Installation

The camera must be installed in an environmentally sealed enclosure that offers protection from moisture or high humidity. It is also recommended that desiccant be installed in the camera enclosure to absorb excess humidity. Failure to install or replace the desiccant as required may cause malfunctions or damage the camera.

15.1 Enclosures

The #18543 CC640 Camera Enclosure completely encloses the camera and has a window through which images are acquired (see Figures 16 through 18). The #26140 Heater Kit is offered to prevent the enclosure's window from frosting over (see Appendix B). The enclosure attaches to a CM202, CM204, or CM206 crossarm via the #18549 Mounting Kit (see Section 15.3).



Figure 16. The #18543 Enclosure Mounted to a Crossarm



Figure 17. The #18543 Enclosure in the Open Position



Figure 18. The Back of the #18543 Enclosure Showing the Lockable Hasp

15.2 Camera Mounting Holes

For flexibility, the camera is equipped with 2 different sets of mounting holes (Figure 19). There are three $\frac{1}{4}$ "-20 threaded mounting holes along the centre of the camera that are spaced 2.0" (50.8mm) apart. The setscrews need to be removed with a $\frac{1}{8}$ " hex Allen key to use the $\frac{1}{4}$ "-20 threaded mounting holes. At least two of the $\frac{1}{4}$ "-20 threaded holes are required for mounting the camera. The camera is also equipped with four #4-40 threaded mounting holes that are spaced 1.5" x 5.0" (38 mm x 127 mm) apart.

Important: The fasteners used for mounting must be 0.375 inches (9.5 mm) or shorter. Using longer fasteners can cause damage to the camera by protruding too far into the camera and damaging the circuit boards. It is recommended to use only the fasteners provided with the camera.



Figure 19. Mounting Hole

15.3 Enclosure Mounting Kit

The #18549 Enclosure Mounting Kit is used to mount the #18543 camera enclosure to a CM202, CM204, or CM206 crossarm. The crossarm then attaches to a tripod, tower, or user-supplied pole (1.0" to 2.1" outer diameter).

Figure 20 shows the camera enclosure mounted to a crossarm via this bracket. The enclosure fastens to the bracket via two #5226 screws (1/4-20 x .5 cap hex grade 5) and two #5428 washers (1/4 flat SS). A u-bolt connects the bracket to a crossarm. Curved notches in the bracket allow you to aim the camera at the desired target.

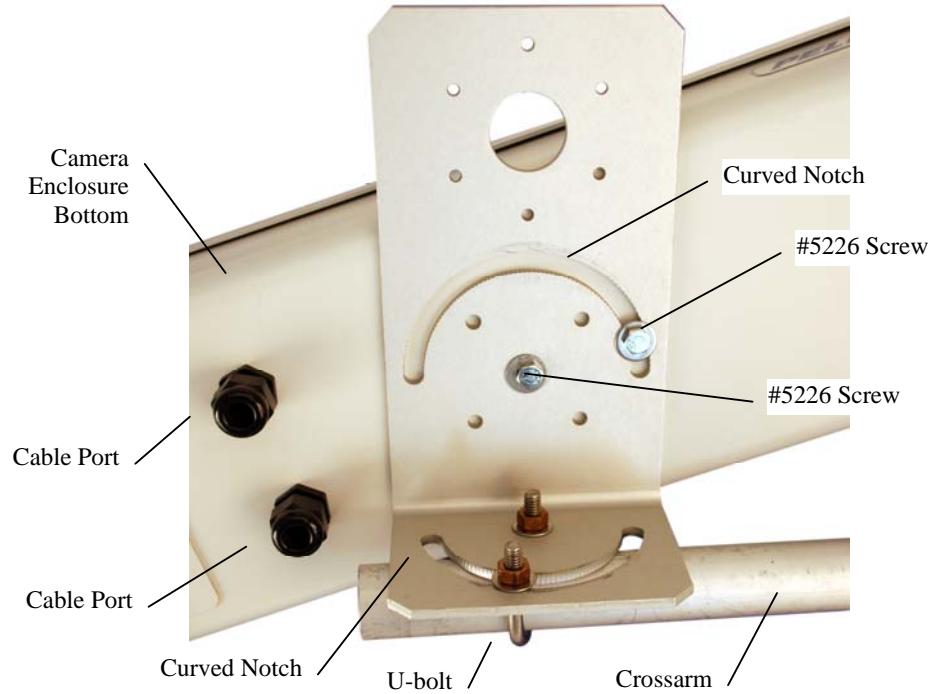

Figure 20. Camera Mount to Crossarm

Appendix A. Quick Start

The quick start section describes setting up a camera to a CR800, CR850, CR1000, or CR3000 datalogger. If using a CR10X, CR510, or CR23X, please call the factory.

- Configure the logger with Device Configuration.
 1. Select the port to be used and select the baud rate to use. If using RS232 connected to a com port, use the following for connections: pin 3 to odd # control port, pin 2 to even # control port, pin 5 to ground.
 2. Select the destination address.
 3. Enter the USR drive size (33 kb x num images + 66 kb). This formula is for very high compression images.
 4. Configure the files manager.
 5. Help for each setting is in Device Configuration.
- Configure the camera.
 1. Select the Pak port to use.
 2. Select the baud rate for the port used.
 3. Select the compression level — very high is suggested. Help for each setting is in Device Configuration.
- Connect the camera to the CR1000 to the desired interface, and the power cable to the CC640 Power the devices.
- Place the camera switch to the “on” position.
- Press the camera “snap” button. Observe that the camera light flashes a few times, pauses then stays illuminated for about 40 seconds.
- To retrieve the image use LoggerNet and connect to the logger. Select “tools” then file control to get to the file control menu.
- In the file control menu select the USR drive. Then observe the image file name with JPG as the extension. Select the file with a left click, and download the image to a directory that you select.
- Go to Windows Explorer, find the image, and open it by double clicking on the file name.

Appendix B. DC Heater Kit

The optional DC heater kit consists of the following components:

- 1- heater with connector attached
- 1- solid state relay
- 1- wire nut
- 1- field power cable



Figure B-1. Components of the #26140 Heater Kit

The solid state relay mounts in the logger enclosure. All other components are in the camera enclosure.

The heater is mounted directly to the camera enclosure window. It gets power from the solid state relay. The solid state relay switches power to the heater and is controlled by a control port. The amount of power needed is dependent upon conditions at each installation and likely won't be the same from installation to installation. It is important to understand what the budget is since the heater requires 1 amp of current.

There are different ways that a customer could run the heater. One method might be to turn power on for a predetermined time prior to taking an image then turn the heater off until the next image is scheduled. Another could be to pulse the heater at a regular interval to keep frost from viewing area.

The steps for installation are

1. Attach the heater to the camera enclosure window
2. Wire the field power cable to the camera and to the camera cable
3. Connect the field power cable to the heater cable
4. Install the solid state relay into the logger enclosure
5. Wire the solid state relay to the logger
6. Program the logger to control the relay
7. Peel the backing from the heater to expose the adhesive and attach the heater so that when the camera is positioned fully against the camera window, it looks through the centre of the heater. The only requirement is that the camera lens be centred on the window of the heater.
8. Run the heater wires under the camera towards the rear of the enclosure.



Figure B-2. Heater Properly Placed in the Enclosure

9. Wire the field power cable inside the camera enclosure to the camera ground and to the source of power for the camera heater.

The lead marked (-) is inserted into the Gnd connection of the camera connector.

The lead marked (+) attached to the power source from the solid state relay and secured with the wire nut.

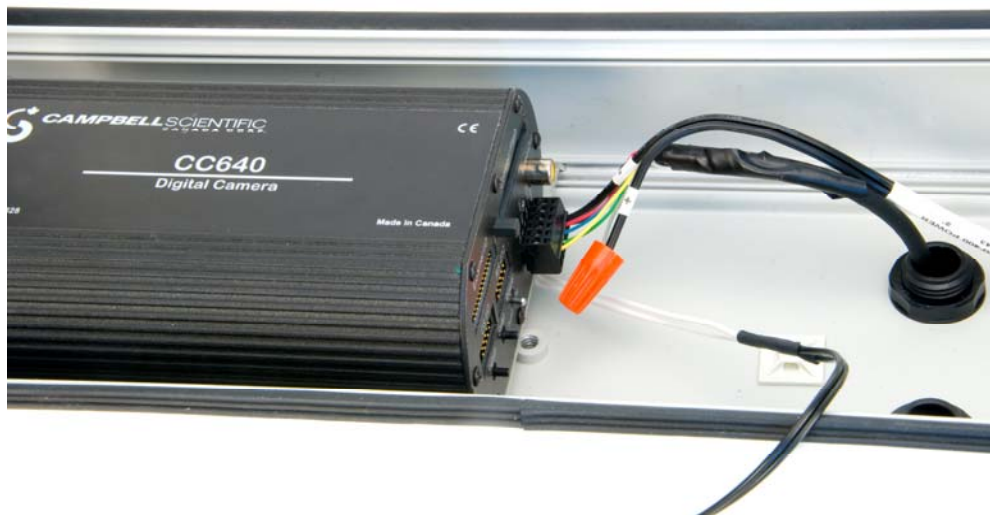

Figure B-3. Field Power Cable Connected to the Camera

10. Connect the connector from the field power cable to the camera heater connector.



Figure B-4. Field Power Cable Connected to the Heater Connector

11. Connect terminal number 1 of the solid state relay to the heater supply wire (labelled "+") with a user-supplied 16-AWG wire.
12. Connect terminal number 2 of the solid state relay to the 12-Vdc source. Do not use the datalogger as a 12 V source.
13. Connect terminal 3 of the solid state relay to the control port on the logger that will be used to control the relay.

14. Connect terminal 4 of the solid state relay to a power ground on the logger.

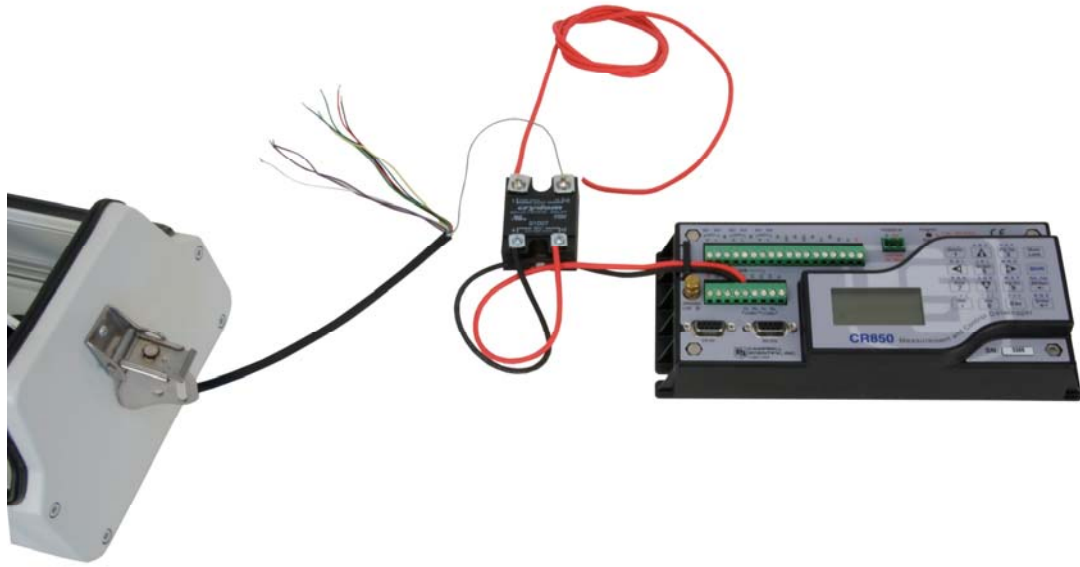

Figure B-5. Solid State Relay Connections

Appendix C. Troubleshooting

Observe the LED Operation

On normal power up the LED will slowly flash 4 times.

If the LED flashes rapidly for several seconds the camera failed one of the power-on tests. In this case factory repair is necessary.

The LED will also flash once if the Setup button is pressed.

The LED will flash twice if the SNAP button is pressed.

During communication or a firmware update the LED will remain ON to indicate a process is in progress that should not be interrupted.

If the power switch is in the ON position the LED should flash once every 5 seconds to indicate that it is running. If the setup button is pressed, the LED will briefly flash once a second to indicate that the camera is ready for setup using the Device Configuration Utility.

Power Connection

If power is applied to the camera and there is no LED activity, check the power supply voltage, and the power supply connections.

Recheck Configuration

Recheck the method for obtaining the image. Reload the configuration files in all devices used for the method selected.

Verify Switch Settings and Configuration

If using the snap button, is the camera switch in the “on” position?

If using a pulse, is the pulse long enough?

Are the configuration files correct for the mode desired?

Appendix D. Example CRBasic Program

The following is a CR800 example program. The CR1000 and CR3000 are programmed similarly.

```
'CR800 Series

'This program allows the user to take a picture on command, time an image, or take a picture based
'on a threshold.
'For the threshold method, the measurement instruction is not included, but the method to take the
'picture is.
'Any or all can be used in the same program

'Declare Variables
Public takepicture,temperature

Sub manual_picture
  PulsePort (4,1000)
  takepicture=0
EndSub

'Main Program
BeginProg
  Scan(10,Sec,1,0)

    'take a picture manually - set takepicture equal to 1 in a numeric
    'screen while connected to the logger
    If takepicture=1 Then
      Call manual_picture
    EndIf

    'Threshold taken picture
    If temperature <> 95 Then
      Call manual_picture
    EndIf

    'trigger camera
    If IfTime (0,15,Min) Then
      PulsePort (4,1000)
    EndIf

  NextScan
EndProg
```

CAMPBELL SCIENTIFIC COMPANIES

Campbell Scientific, Inc. (CSI)

815 West 1800 North
Logan, Utah 84321
UNITED STATES

www.campbellsci.com • info@campbellsci.com

Campbell Scientific Africa Pty. Ltd. (CSAf)

PO Box 2450
Somerset West 7129
SOUTH AFRICA

www.csafrica.co.za • sales@csafrica.co.za

Campbell Scientific Australia Pty. Ltd. (CSA)

PO Box 444
Thuringowa Central
QLD 4812 AUSTRALIA

www.campbellsci.com.au • info@campbellsci.com.au

Campbell Scientific do Brazil Ltda. (CSB)

Rua Luisa Crapsi Orsi, 15 Butantã
CEP: 005543-000 São Paulo SP BRAZIL

www.campbellsci.com.br • suporte@campbellsci.com.br

Campbell Scientific Canada Corp. (CSC)

11564 - 149th Street NW
Edmonton, Alberta T5M 1W7
CANADA

www.campbellsci.ca • dataloggers@campbellsci.ca

Campbell Scientific Centro Caribe S.A. (CSCC)

300N Cementerio, Edificio Breller
Santo Domingo, Heredia 40305
COSTA RICA

www.campbellsci.cc • info@campbellsci.cc

Campbell Scientific Ltd. (CSL)

Campbell Park
80 Hathern Road
Shepshed, Loughborough LE12 9GX
UNITED KINGDOM

www.campbellsci.co.uk • sales@campbellsci.co.uk

Campbell Scientific Ltd. (France)

Miniparc du Verger - Bat. H
1, rue de Terre Neuve - Les Ulis
91967 COURTABOEUF CEDEX
FRANCE

www.campbellsci.fr • info@campbellsci.fr

Campbell Scientific Spain, S. L.

Psg. Font 14, local 8
08013 Barcelona
SPAIN

www.campbellsci.es • info@campbellsci.es

Campbell Scientific Ltd. (Germany)

Fahrenheitstrasse13, D-28359 Bremen
GERMANY

www.campbellsci.de • info@campbellsci.de